

AIR EXCELLENT

AE48C straight connector & airtightness parts



Features & benefits

- For connecting straight pieces of ductwork
- For installation in ceilings and walls
- For circular AE48C ductwork (DN90/75 mm)
- Easy to mount with seal-ring and click-ring
- Anti-static and anti-bacterial properties
- Made of virgin raw PP materials
- Part of the TÜV SÜD certified Air Excellent system

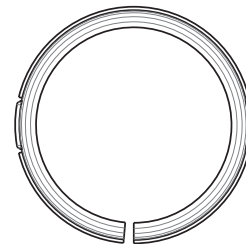
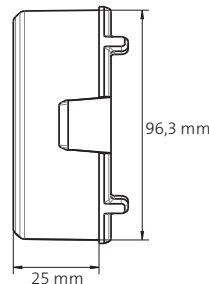
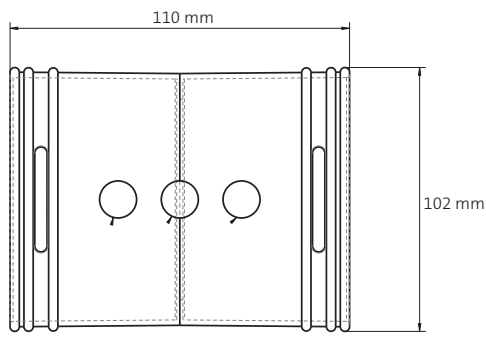

Airtight seal + click-ring

The EPDM seal-ring and PP click-ring for the circular ductwork are vital components of the Air Excellent system and ensure airtight connections. These components are used to make all mechanical connections between the ductwork, accessories and the distribution boxes.



Mounting brackets

PP Mounting brackets ensure a steady installation of the duct. It is advised to use one bracket per 2 meters of duct run. Multiple brackets can be connected with each other enabling compact installations with parallel duct runs.

